

3 Circuit Track & Spot



KAZZAR[®]
LIGHTING & CONTROLS



KAZZAR[®]

LIGHTING & CONTROLS

At Kazzar Lighting, we aim to provide products and solutions that make a difference. Our commitment goes beyond just lighting for vision; we emphasize the importance of lighting that promotes wellbeing, comfort and visual pleasure. Drawing on our vast experience, we focus on products that positively influence visual perception of space. With Kazzar Lighting & Controls, step into a world where light meets purpose.

TEL: +44 208 090 1413

EML: sales@kazzar.net

www.kazzar.net

KAZZAR LIGHTING & CONTROLS

Temple House, 1 Regatta Place

Marlow Road, Bourne End,

South Bucks, SL5 8TD, UK

Contents

| | |
|---|----|
| TRACK AND SPOT BY KAZZAR LIGHTING | 4 |
| SPOTS AND FIXTURES FOR 3 CIRCUIT TRACKS | |
| - Kirana Zoom Spot | 8 |
| - Brigid Spot | 10 |
| - Eury's Spot | 12 |
| - Kann Spot | 14 |
| - Solen LED Spot | 16 |
| - Mikkos Linear | 18 |
| 3 CIRCUIT TRACK SYSTEMS | 21 |
| - Track Components | 22 |

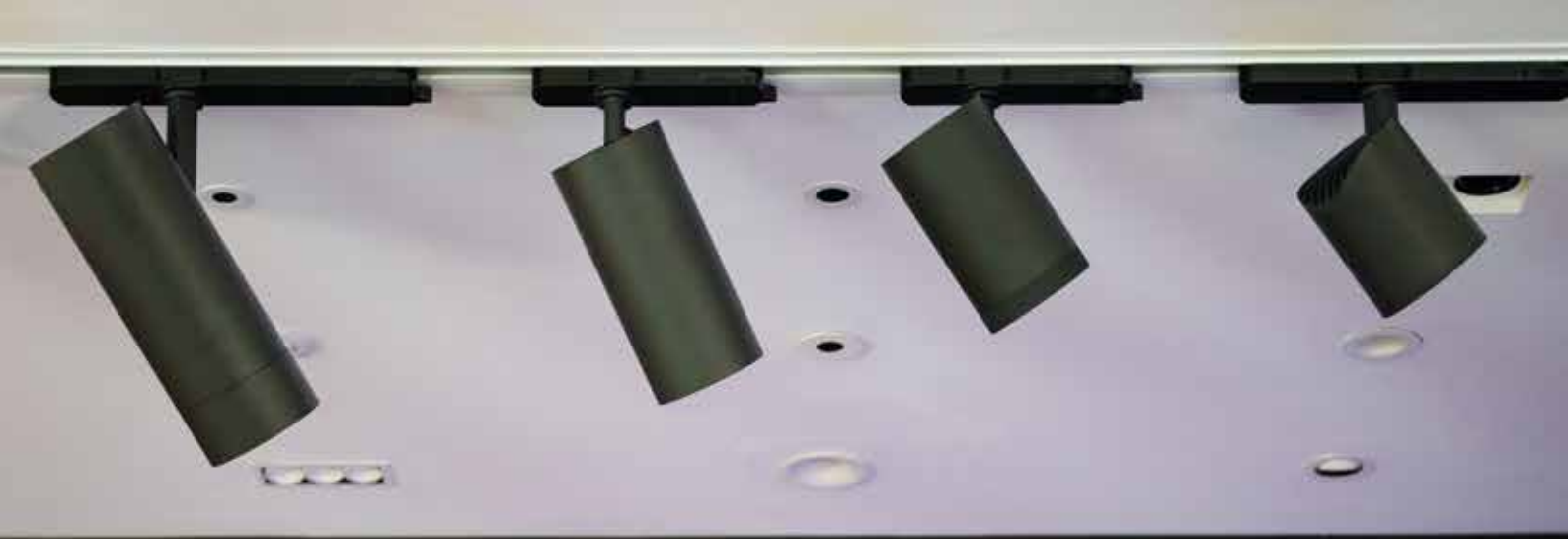

Track and Spot by Kazzar Lighting

Welcome to Kazzar Lighting's Track and Spot catalogue, where we bring you the practical brilliance of track and spot lighting for your commercial display and design needs. Our commitment to these lighting solutions is rooted in their enduring appeal and adaptability, making them indispensable tools for lighting professionals, retail designers, interior designers, and architects.

Track lighting has a rich history of serving various industries and continues to evolve, offering a reliable foundation for your lighting needs. It shines brightest in spaces like retail outlets, museums, and galleries, where the ability to customize lighting for different displays is essential. Our catalogue features the Nordic Aluminium track system, a dependable choice that simplifies the task of lighting configuration, ensuring your exhibits and products are showcased in the best possible light.

The true beauty of track lighting lies in its flexibility. It grants you the freedom to create various lighting effects and scene settings, adapting effortlessly to the changing demands of your space. Furthermore, our carefully selected spotlights enhance this adaptability, boasting optical characteristics that suit a wide range of requirements. With adjustable beam angles, these spotlights provide versatility without the need for complex reflector and lens changes, ensuring your lighting is both efficient and effective.

Beyond versatility, track lighting offers practical advantages. The track itself delivers power to the fixtures, reducing the need for extensive ceiling wiring, simplifying installations, and minimizing visual clutter. Additionally, our track system enables individual dimming control, thanks to integrated DALI or wireless lighting controls within the spotlights. This level of control ensures you can create the perfect atmosphere and seamlessly integrate emergency lighting when necessary.

Collaborating with creative interior and lighting designers, Kazzar Lighting delivers not just lighting solutions but functional and engaging environments. We invite you to explore our catalog and discover how our track system and spotlights can assist you in crafting well-lit, immersive spaces that meet your clients' needs. Welcome to the world of practical, adaptable lighting solutions with Kazzar Lighting as your trusted partner.





Spots and Fixtures for 3 Circuit Track



Kirana Zoom Spot

8



Brigid Spot

10



Eurys Spot

12



Kann Spot

14



Solen LED Spot

16



Mikkos Linear

18

Kirana Zoom Spot



Introducing the Kirana Zoom Spot

Adjustable Spot Light: Precision Illumination for Art and Display

Illuminate art and displays effortlessly with the Kirana Zoom Spot Light.

Tailored for museums, galleries, and exhibits, Kirana offers focused lighting control. Seamlessly fitting into setups, Kirana's adjustable zoom spot shifts from 15° to 60°, highlighting every detail. Dim from 10% to 100% using the rear potentiometer, or opt for DALI or Casambi wireless systems for added ease.

Available for 3-circuit and 1-circuit Global tracks, Kirana Zoom Spot Light transforms spaces into showcases. Ideal for artists and curators, it's precision-made lighting.

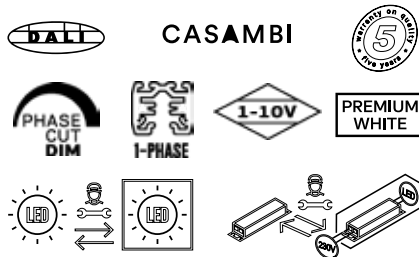

15°, 35°, 60°

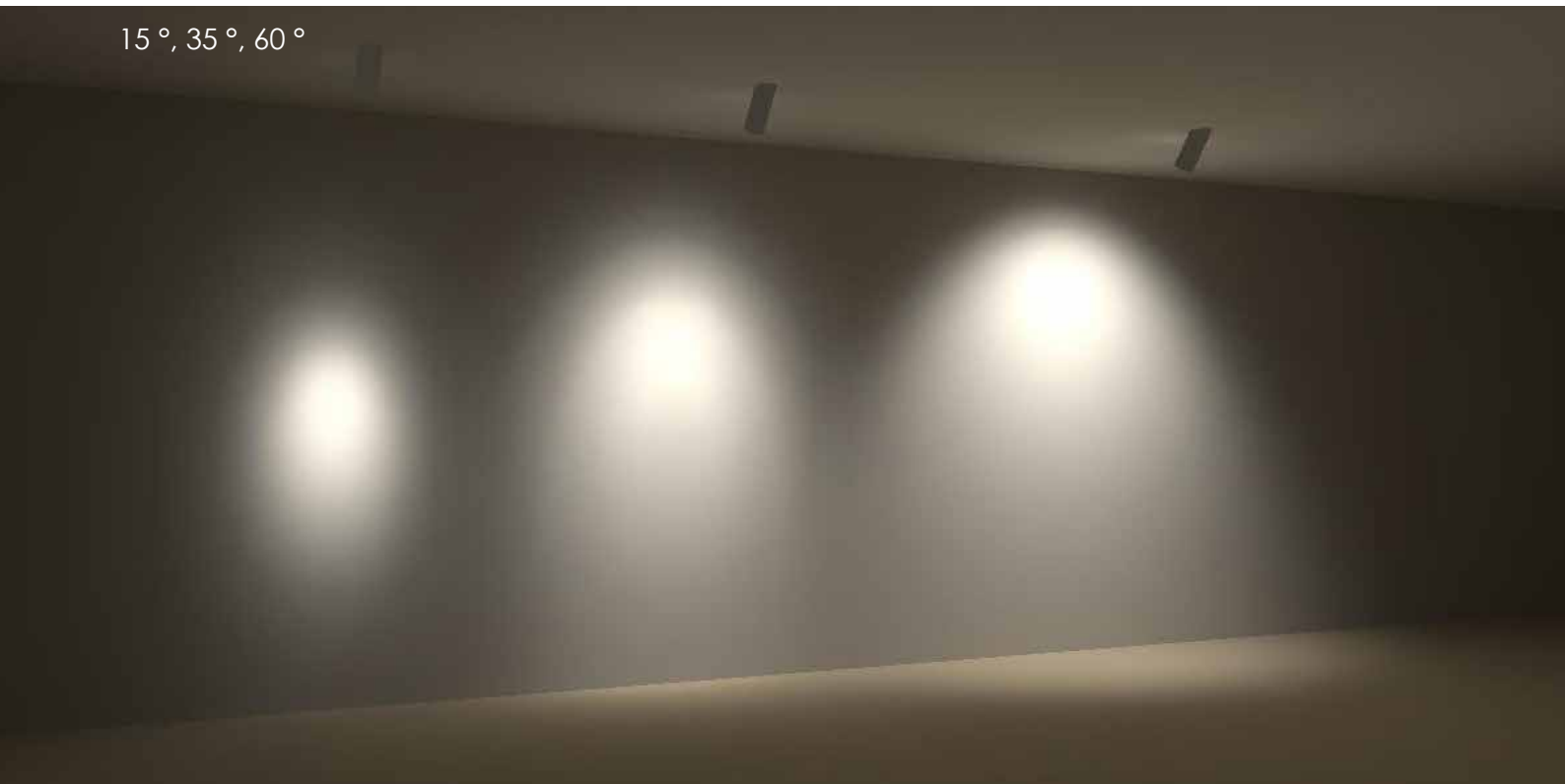

Kirana Zoom Spot

Light Performance:

- Beam Angles: 15° - 60° Zoom Lens
- Luminaire Efficacy: Max. 74Lm/W
- Luminous Flux: Max. 2150Lm
- CCT: 3000K
- CRI: >90
- Adjustability: 350° rotation and 90° tiltable
- Chromaticity tolerance: 3

Electrical:

- Connected Load: Max 29W
- Mains Voltage: 220-240V / 50-60Hz
- Control: Mains Dim, DALI, Casambi, Onboard Dim

Compliance:

- Electrical Safety Class: Class I
- Ingress Protection: IP20
- Material: Die cast Aluminium
- Max. ambient temperature: 35°C
- Weight: 1.10kg

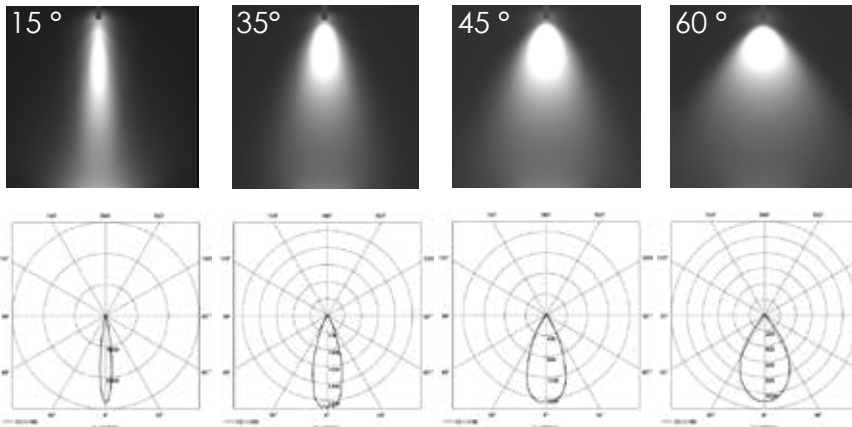

| Part No. | Power | CCT | CRI | Angle | Colour | Control |
|-----------------|---------------|-----------------|-------------|---------------------|-----------------------|---------------------|
| KIR-3C - | 29 29W | 3 3000K | 9 90 | ZM 15° - 60° | WH White | MD Mains Dim |
| | | 4 4000K | | | BLK Black | DA DALI |
| | | GRY Grey | | | CA Casambi | |
| | | | | | OB Onboard Dim | |

*Part number sample - KIR-3C-29-3-9-ZM-WH-MD

*Kirana is also available in other configurations upon request. Please contact the Sales team for more information.

Brigid Spot



Introducing the Brigid Spot

Brigid Spot is a 3-phase and single phase track spotlight that offers a harmonious blend of aesthetics and functionality. Its design and features make it a top choice for various lighting applications, in particular retail segment thanks to the beam and light source options.

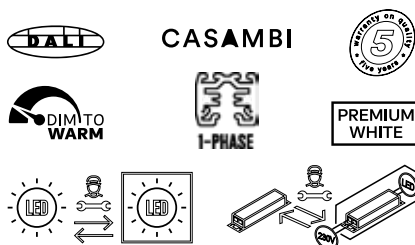

Light Performance:

- Beam Angles: 15°, 24°, 45°, 55°
- Luminaire Efficacy: Max. 125Lm/W
- Luminous Flux: Max. 4400Lm
- CCT: 2700K, 3000K, 4000K, 5700K
- CRI: >80, >90, >97
- Adjustability: 350° rotation and 90° tilttable
- Chromaticity tolerance: 3

Electrical:

- Connected Load: Max 38.5W
- Mains Voltage: 220-240V / 50-60Hz
- Control: Switch, Phase Dim, DALI, Casambi

Compliance:

- Electrical Safety Class: Class II
- Ingress Protection: IP20
- Material: Die cast Aluminium
- Max. ambient temperature: 35°C
- Weight: 0.65kg

Brigid Spot

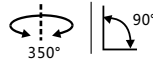
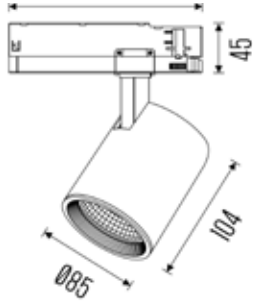

WHITE



GREY



BLACK

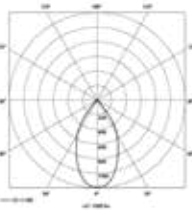
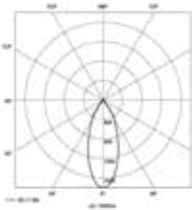
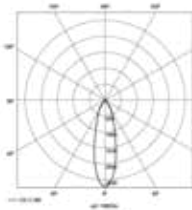
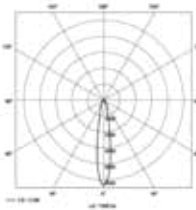
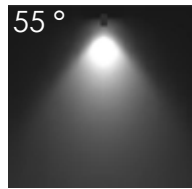
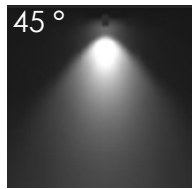
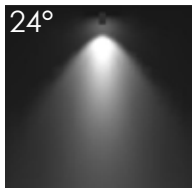
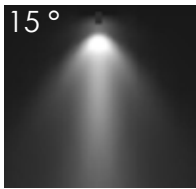

| Part No. | Power | CCT | CRI | Angle | Colour | Control |
|-----------------|-------------|-------|----------------|---------------|-----------------|---------------------|
| BRI-3C - | 14 | 14W | 3 3000K | 8 80 | 15 15° | WH White |
| | 18.5 | 18.5W | 4 4000K | 9 90 | 24 24° | BLK Black |
| | | | 97 97 | 45 45° | GRY Grey | SW Switch |
| | | | | 55 55° | | PD Phase Dim |
| | | | | | | DA DALI |
| | | | | | | CA Casambi |

*Part number sample - BRI-3C-14-3-8-15-WH-SW

*Brigid is also available in other configurations upon request. Please contact the Sales team for more information.



Eurys Spot



Introducing the Eurys Spot

Eurys is a robust, high output 3-phase track spot with a wide range of applications. An industrial spot with great aesthetics allows this to be used in any application where high light output is needed from high heights.

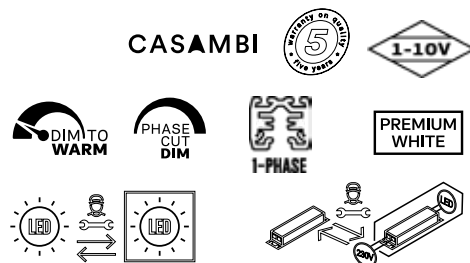

Light Performance:

- Beam Angles: 12°, 30°, 45°, 60°
- Luminaire Efficacy: Max. 137Lm/W
- Luminous Flux: Max. 4500Lm
- CCT: 2700K, 3000K, 4000K, 5700K
- CRI: >80, >90, >97
- Adjustability: 350° rotation and 90° tilttable
- Chromaticity tolerance: 3

Electrical:

- Connected Load: 38.5W
- Mains Voltage: 220-240V / 50-60Hz
- Control: Switch, Phase Dim, DALI, Casambi

Compliance:

- Electrical Safety Class: Class II
- Ingress Protection: IP20
- Material: Die cast Aluminium
- Max. ambient temperature: 35°C
- Weight: 1.80kg

Eurys Spot

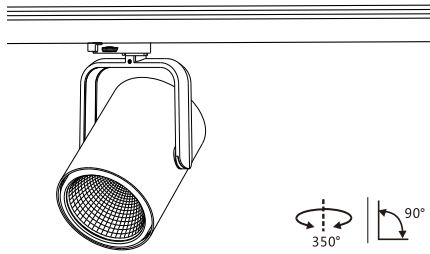

WHITE



GREY



BLACK

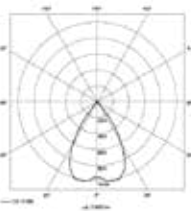
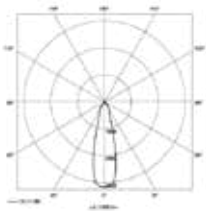
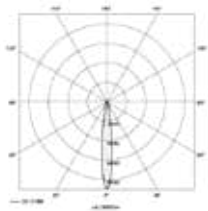
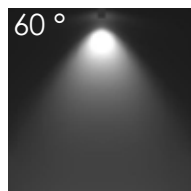
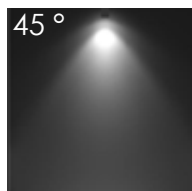
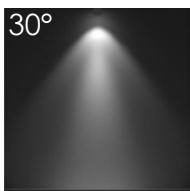

| Part No. | Power | CCT | CRI | Angle | Colour | Control | |
|-----------------|-------------|-------|----------------|--------------|---------------|------------------|---------------------|
| EUR-3C - | 9.5 | 9.5W | 3 3000K | 8 80 | 12 12° | WH White | SW Switch |
| | 18.5 | 18.5W | 4 4000K | 9 90 | 30 30° | BLK Black | PD Phase Dim |
| | 26 | 26W | | 97 97 | 45 45° | GRY Grey | DA DALI |
| | 30 | 30W | | | 60 60° | | CA Casambi |
| | 33 | 33W | | | | | |

*Part number sample - EUR-3C-9.5-3-8-12-WH-SW

*Eurys is also available in other configurations upon request. Please contact the Sales team for more information.



Kann Spot



Introducing the Kann Spot

Kann is a high-performance track spotlight designed for optimal illumination. It offers a blend of efficiency and versatility, making it suitable for various applications.

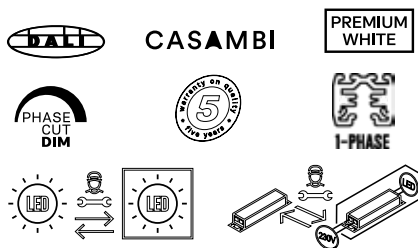

Light Performance:

- Beam Angles: 15°, 25°, 45°, 65°
- Luminaire Efficacy: Max. 159Lm/W
- Luminous Flux: Max. 2900Lm
- CCT: 2700K - 5700K
- CRI: >80, >90, >97
- Adjustability: 350° rotation and 90° tiltable
- Chromaticity tolerance: 2

Electrical:

- Connected Load: 38.5W
- Mains Voltage: 220-240V / 50-60Hz
- Control: Switch, Phase Dim, DALI, Casambi

Compliance:

- Electrical Safety Class: Class I
- Ingress Protection: IP20
- Material: Die cast Aluminium
- Max. ambient temperature: 35°C
- Weight: 0.60kg

Kann Spot

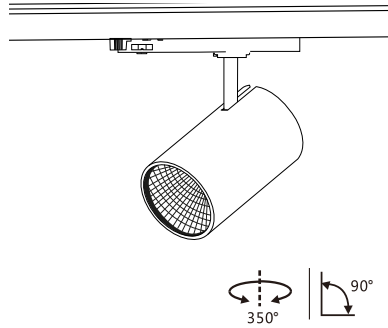
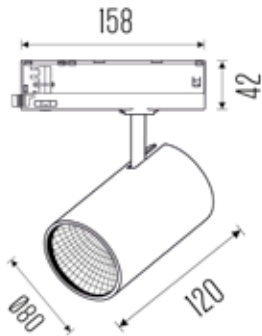

WHITE



GREY



BLACK

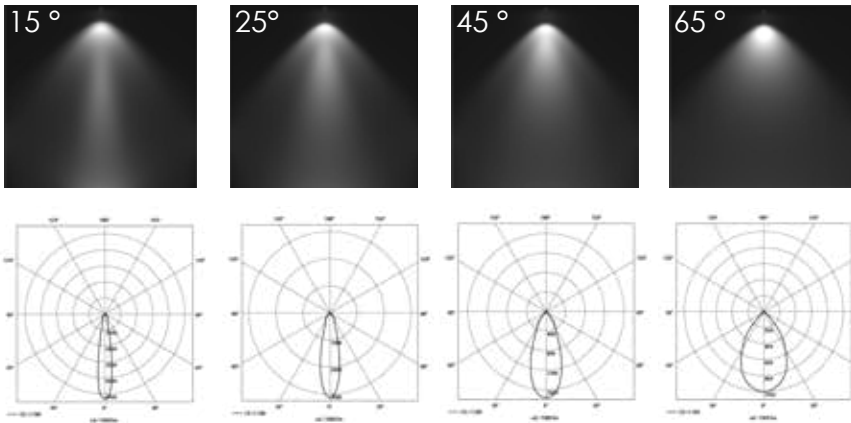

| Part No. | Power | CCT | CRI | Angle | Colour | Control | |
|-----------------|-----------|-----|----------------|--------------|---------------|------------------|---------------------|
| KAN-3C - | 11 | 11W | 3 3000K | 8 80 | 15 15° | WH White | SW Switch |
| | 19 | 19W | 4 4000K | 9 90 | 25 25° | BLK Black | PD Phase Dim |
| | 23 | 23W | | 97 97 | 45 45° | GRY Grey | DA DALI |
| | | | | | 65 65° | | CA Casambi |

*Part number sample - KAN-3C-11-3-8-15-WH-SW

*Kann is also available in other configurations upon request. Please contact the Sales team for more information.

Solen LED Spot



Introducing the Solen LED Spot

Solen LED is a universal 3-phase track spotlight ideal for every retail project. Its stylish design, with the driver incorporated in the track adapter, offers a range of CCT, dim-to-warm, Spectral LED, special colors for retail use, reflectors, and various accessories.

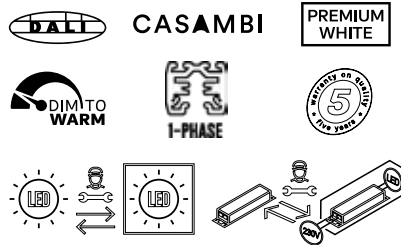

Light Performance:

- Beam Angles: 25°, 30°, 36°, 45°, 60°
- Luminaire Efficacy: Max. 127Lm/W
- Luminous Flux: Max. 3150Lm
- CCT: 2700K - 5700K
- CRI: >80, >90, >97
- Adjustability: 350° rotation and 90° tilttable
- Chromaticity tolerance: 3

Electrical:

- Connected Load: 30W
- Mains Voltage: 220-240V / 50-60Hz
- Control: Switch, Phase Dim, DALI, Casambi

Compliance:

- Electrical Safety Class: Class II
- Ingress Protection: IP20
- Material: Die cast Aluminium
- Max. ambient temperature: 35°C
- Weight: 0.90kg

Solen LED Spot

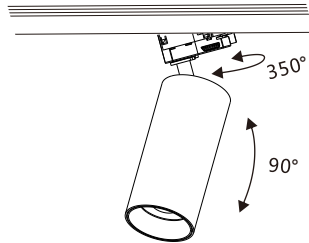
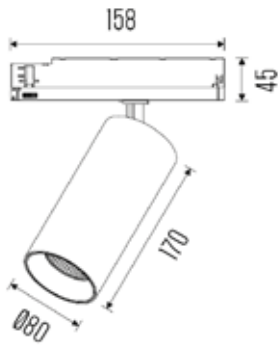

WHITE



GREY



BLACK

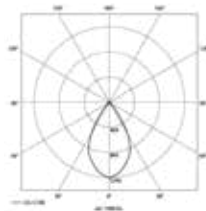
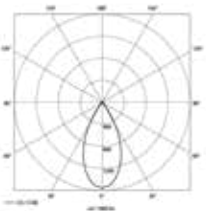
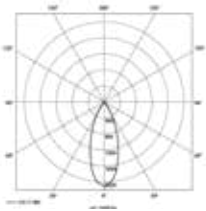
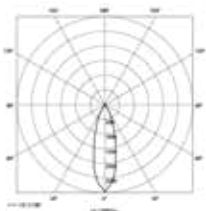
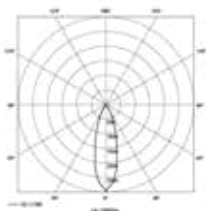
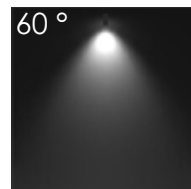
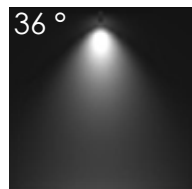
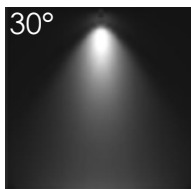

| Part No. | Power | CCT | CRI | Angle | Colour | Control |
|-----------------|-------------------|----------------|--------------|---------------|------------------|---------------------|
| SOL-3C - | 14 14W | 3 3000K | 8 80 | 25 25° | WH White | SW Switch |
| | 18.5 18.5W | 4 4000K | 9 90 | 30 30° | BLK Black | PD Phase Dim |
| | 27 27W | | 97 97 | 36 36° | GRY Grey | DA DALI |
| | 30 30W | | | 45 45° | | CA Casambi |
| | | | | 60 60° | | |

*Part number sample - SOL-3C-14-3-8-25-WH-SW

*Solen LED is also available in other configurations upon request. Please contact the Sales team for more information.



Introducing the Mikkos Linear

Mikkos Linear is a linear track luminaire that excels in simplicity. Straightforward, powerful, and energy-efficient. Without unnecessary ballast, it's perfect for larger areas such as industrial zones, car showrooms, or retail spaces.

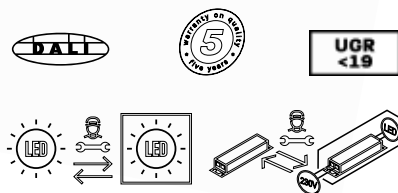

Light Performance:

- Beam Angles: Lens 30°, 60°, 90° & Double Asymmetric
- Luminaire Efficacy: Max.141Lm/52W
Max.9750Lm/68W
- Luminous Flux: Max. 7300Lm
- CCT: 3000K & 4000K
- CRI: >80, >90
- Adjustability : 50° rotation
- Chromaticity Tolerance: 3

Electrical:

- Connected Load: 52W, 68W
- Mains Voltage: 220-240V / 50-60Hz
- Control: Switch, DALI

Compliance:

- Electrical Safety Class: Class I
- Ingress Protection: IP20
- Material: Die cast Aluminium
- Max. ambient temperature: 35°C
- Weight: 52W 2.60kg
68W 3.40kg

Mikkos Linear

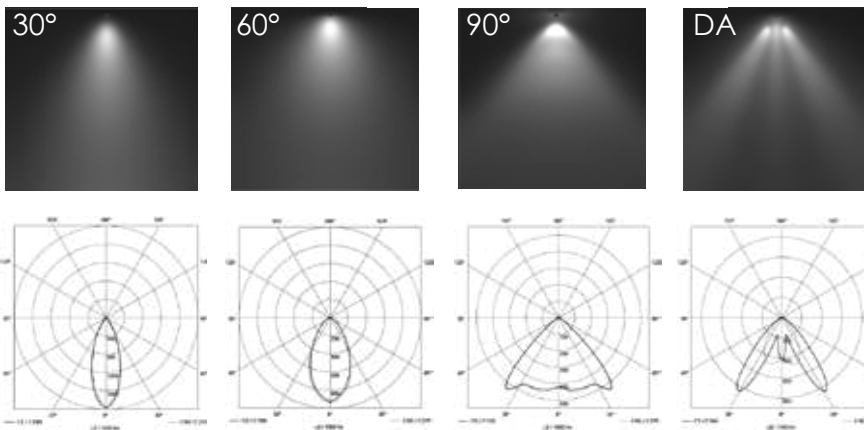
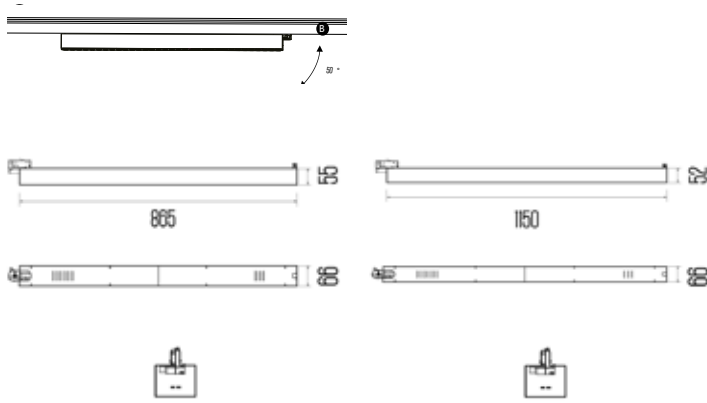

| Part No. | Power | CCT | CRI | Angle | Colour | Control |
|-----------------|---------------|----------------|-----------------------------|---------------|------------------|------------------|
| MIK-3C - | 52 52W | 3 3000K | 8 80 | 30 30° | WH White | SW Switch |
| | 68 68W | 4 4000K | 9 90 | 60 60° | BLK Black | DA DALI |
| | | | | 90 90° | GRY Grey | |
| | | | DA Double Asymmetric | | | |

*Part number sample - MIK-3C-52-3-8-30-WH-SW

*Mikkos is also available in other configurations upon request. Please contact the Sales team for more information.



3 Circuit Track Systems

The 3 Circuit 240V Track System, especially our featured Global Track, is a testament to over 40 years of innovation in the lighting industry. Renowned for its compatibility, this track seamlessly integrates with a wide range of lighting fixtures from different manufacturers, ensuring ease of installation and future-proofing for upgrades.

This system ingeniously delivers mains voltage power through three conductors with a shared common neutral, allowing for three independently controlled switch circuits. Users can manage each circuit separately, either through traditional switching or analogue dimming methods like mains phase cut. This flexibility enables customized lighting setups tailored to various needs and atmospheres.

Embracing the digital era, the 3 Circuit Track now includes an additional data bus for digital dimming, primarily utilizing DALI systems. This advancement not only enhances lighting management but also promotes energy efficiency and smart building integration. The Global Track, thus, represents a blend of time-tested reliability and modern technology, offering an unrivaled lighting solution for diverse environments.



3 CIRCUIT TRACK 240V STANDARD

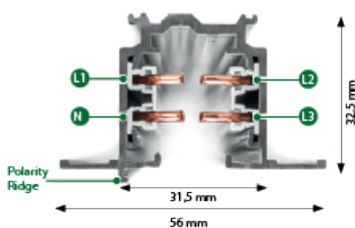

- 240v Switch ON/OFF
- Mains dimming
- Casambi Fixtures
- Permanent live for emergency
- All above can be mixed

3 CIRCUIT TRACK 240V DALI

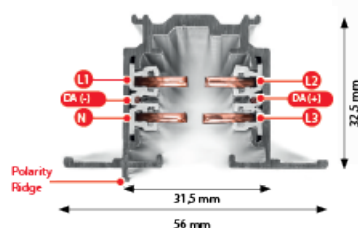

- DALI ballest track spots (Nordic Pulse)
- DALI emergency
- Switch ON/OFF
- Mains dimming
- Casambi Fixtures
- Permanent live for emergency
- All above can be mixed

Track Components

1. TRACK



SURFACE MOUNTED TRACK

| STANDARD | | DALI | | Length | Colour Finish |
|----------------------|--|---------------------------|--|-----------|---------------|
| Part No. | | Part No. | | | |
| KXTS4-100-WHT | | KXTSC6100-WHT-DALI | | 1M | WHITE |
| KXTS4-100-BLK | | KXTSC6100-BLK-DALI | | 1M | BLACK |
| KXTS4-100-GRY | | KXTSC6100-GRY-DALI | | 1M | GREY |
| KXTS4-200-WHT | | KXTSC6200-WHT-DALI | | 2M | WHITE |
| KXTS4-200-BLK | | KXTSC6200-BLK-DALI | | 2M | BLACK |
| KXTS4-200-GRY | | KXTSC6200-GRY-DALI | | 2M | GREY |
| KXTS4-300-WHT | | KXTSC6300-WHT-DALI | | 3M | WHITE |
| KXTS4-300-BLK | | KXTSC6300-BLK-DALI | | 3M | BLACK |
| KXTS4-300-GRY | | KXTSC6300-GRY-DALI | | 3M | GREY |



RECESSED TRACK

| STANDARD | | DALI | | Length | Colour Finish |
|-----------------------|--|----------------------------|--|-----------|---------------|
| Part No. | | Part No. | | | |
| KXTSF4-100-WHT | | KXTSCF6100-WHT-DALI | | 1M | WHITE |
| KXTSF4-100-BLK | | KXTSCF6100-BLK-DALI | | 1M | BLACK |
| KXTSF4-100-GRY | | KXTSCF6100-GRY-DALI | | 1M | GREY |
| KXTSF4-200-WHT | | KXTSCF6200-WHT-DALI | | 2M | WHITE |
| KXTSF4-200-BLK | | KXTSCF6200-BLK-DALI | | 2M | BLACK |
| KXTSF4-200-GRY | | KXTSCF6200-GRY-DALI | | 2M | GREY |
| KXTSF4-300-WHT | | KXTSCF6300-WHT-DALI | | 3M | WHITE |
| KXTSF4-300-BLK | | KXTSCF6300-BLK-DALI | | 3M | BLACK |
| KXTSF4-300-GRY | | KXTSCF6300-GRY-DALI | | 3M | GREY |

FIX POINT

STANDARD

Part No.
KGA70-WHT
KGA70-BLK
KGA70-GRY



Colour Finish

WHITE
 BLACK
 GREY



Track Components

2. POWER FEEDS (POWER SUPPLY BASED CONNECTORS)

END FEED

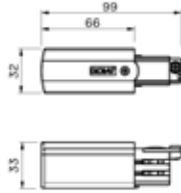

STANDARD

Part No.

KXTS11-WHT-RIGHT
KXTS11-BLK-RIGHT
KXTS11-GRY-RIGHT

DALI

Part No.

KXTSC611-WHT-DALI
KXTSC611-BLK-DALI
KXTSC611-GRY-DALI

Polarity



Colour Finish

WHITE

BLACK

GREY



KXTS12-WHT-LEFT
KXTS12-BLK-LEFT
KXTS12-GRY-LEFT

KXTSC612-WHT-DALI
KXTSC612-BLK-DALI
KXTSC612-GRY-DALI



WHITE

BLACK

GREY

L-FEED

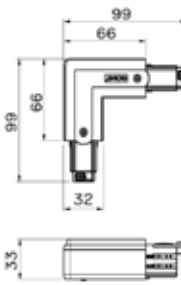

STANDARD

Part No.

KXTS34-WHT-RIGHT
KXTS34-BLK-RIGHT
KXTS34-GRY-RIGHT

DALI

Part No.

KXTSC634-WHT-DALI
KXTSC634-BLK-DALI
KXTSC634-GRY-DALI

Polarity



Colour Finish

WHITE

BLACK

GREY



KXTS35-WHT-LEFT
KXTS35-BLK-LEFT
KXTS35-GRY-LEFT

KXTSC635-WHT-DALI
KXTSC635-BLK-DALI
KXTSC635-GRY-DALI



WHITE

BLACK

GREY

T-FEED

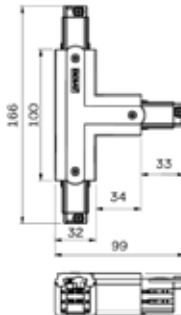

STANDARD

Part No.

KXTS36-WHT-RR
KXTS36-BLK-RR
KXTS36-GRY-RR

DALI

Part No.

KXTSNC36-WHT-RR
KXTSNC36-BLK-RR
KXTSNC36-GRY-RR

Polarity



Colour Finish

WHITE

BLACK

GREY



KXTS37-WHT-LL
KXTS37-BLK-LL
KXTS37-GRY-LL

KXTSNC37-WHT-LL
KXTSNC37-BLK-LL
KXTSNC37-GRY-LL



WHITE

BLACK

GREY

KXTS39-WHT-RL
KXTS39-BLK-RL
KXTS39-GRY-RL

KXTSNC39-WHT-RL
KXTSNC39-BLK-RL
KXTSNC39-GRY-RL



WHITE

BLACK

GREY

KXTS40-WHT-LR
KXTS40-BLK-LR
KXTS40-GRY-LR

KXTSNC40-WHT-LR
KXTSNC40-BLK-LR
KXTSNC40-GRY-LR



WHITE

BLACK

GREY

X-FEED

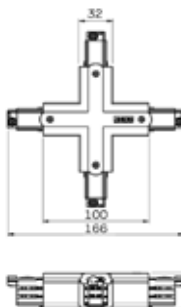

STANDARD

Part No.

KXTS38-WHT
KXTS38-BLK
KXTS38-GRY

DALI

Part No.

KXTSNC638-WHT
KXTSNC638-BLK
KXTSNC638-GRY

Polarity



Colour Finish

WHITE

BLACK

GREY



MIDDLE-FEED



STANDARD

Part No.

KXTS14-WHT
KXTS14-BLK
KXTS14-GRY

DALI

Part No.

KXTSNC614-WHT
KXTSNC614-BLK
KXTSNC614-GRY

Colour Finish

WHITE

BLACK

GREY

Track Components

3. CONNECTORS WITHOUT OPTION FOR POWER SUPPLY

STRAIGHT CONNECTOR

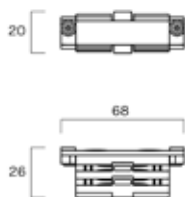

STANDARD
Part No.
KXTS21-WHT
KXTS21-BLK
KXTS21-GRY

DALI
Part No.
KXTSC621-WHT
KXTSC621-BLK
KXTSC621-GRY

Colour Finish
WHITE
BLACK
GREY

FLEXIBLE CORNER CONNECTOR

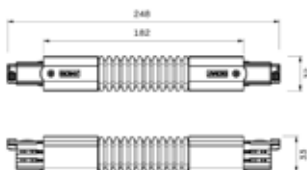

STANDARD
Part No.
KXTS23-WHT
KXTS23-BLK
KXTS23-GRY

DALI
Part No.
KXTSC623-WHT
KXTSC623-BLK
KXTSC623-GRY

Colour Finish
WHITE
BLACK
GREY

ADJUSTABLE CORNER CONNECTOR

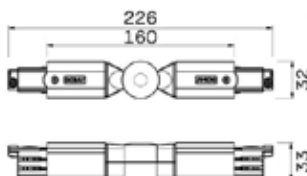

STANDARD
Part No.
KXTS24-WHT
KXTS24-BLK
KXTS24-GRY

Colour Finish
WHITE
BLACK
GREY

END CAP

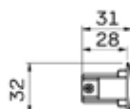

STANDARD + DALI
Part No.
KXTS41-WHT
KXTS41-BLK
KXTS41-GRY

Colour Finish
WHITE
BLACK
GREY

4. RECESSED TRACK COVER PLATES



STANDARD
Part No.
KXTSF10-WHT
KXTSF10-BLK
KXTSF10-GRY

DALI
Part No.
KXTSF6-10-WHT
KXTSF6-10-BLK
KXTSF6-10-GRY

Colour Finish
WHITE
BLACK
GREY



STANDARD
Part No.
KXTSF30-WHT
KXTSF30-BLK
KXTSF30-GRY

DALI
Part No.
KXTSF6-30-WHT
KXTSF6-30-BLK
KXTSF6-30-GRY

Colour Finish
WHITE
BLACK
GREY

Track Components

5. WIRE SUSPENSION SET



STANDARD

| Part No. | Description | Colour Finish |
|-------------------------|--------------------------|---------------|
| KSPW11WLC-3/1.5M | Track clip wire set 1.5m | WHITE |
| KSPW11WLC-3/3M | Track clip wire set 3m | WHITE |
| KSPW11WLC-3/5M | Track clip wire set 5m | WHITE |
| KSPW11WLC-2/1.5M | Track clip wire set 1.5m | BLACK |
| KSPW11WLC-2/3M | Track clip wire set 3m | BLACK |
| KSPW11WLC-2/5M | Track clip wire set 5m | BLACK |
| KSPW11WLC-1/1.5M | Track clip wire set 1.5m | GREY |
| KSPW11WLC-1/3M | Track clip wire set 3m | GREY |
| KSPW11WLC-1/5M | Track clip wire set 5m | GREY |



STANDARD

| Part No. | Description | Colour Finish |
|-------------------------|---------------------------|---------------|
| KSPW11WLC-3/1.5M | Track clamp wire set 1.5m | WHITE |
| KSPW11WLC-3/3M | Track clamp wire set 3m | WHITE |
| KSPW11WLC-3/5M | Track clamp wire set 5m | WHITE |
| KSPW11WLC-2/1.5M | Track clamp wire set 1.5m | BLACK |
| KSPW11WLC-2/3M | Track clamp wire set 3m | BLACK |
| KSPW11WLC-2/5M | Track clamp wire set 5m | BLACK |
| KSPW11WLC-1/1.5M | Track clamp wire set 1.5m | GREY |
| KSPW11WLC-1/3M | Track clamp wire set 3m | GREY |
| KSPW11WLC-1/5M | Track clamp wire set 5m | GREY |

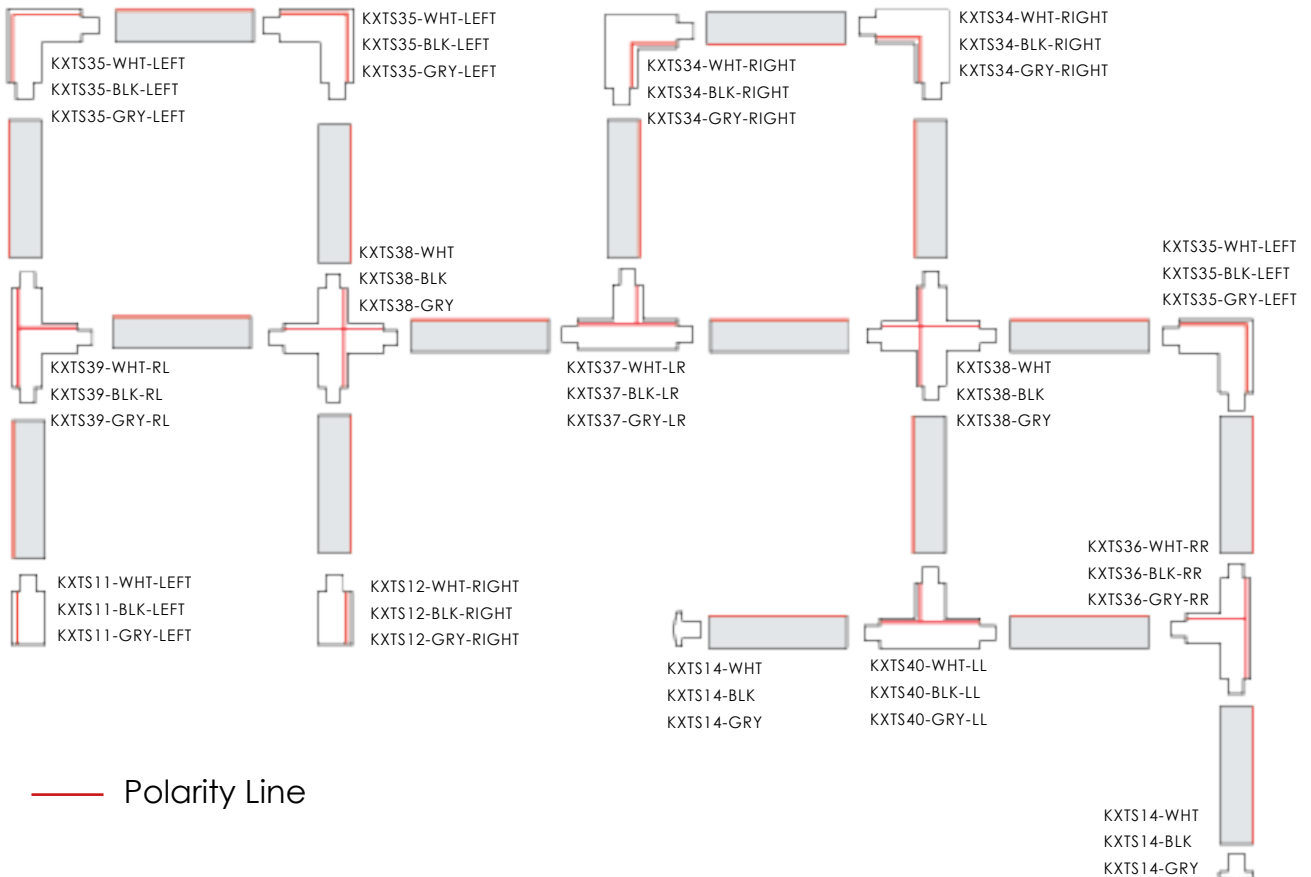



KAZZAR[®]

LIGHTING & CONTROLS

TEL: +44 208 090 1413

EML: sales@kazzar.net

www.kazzar.net

KAZZAR LIGHTING & CONTROLS
Temple House, 1 Regatta Place
Marlow Road, Bourne End,
South Bucks, SL5 8TD, UK